

Portable Tanker Access Ladder System



- Designed to position workers over tank manways
- Lightweight aircraft aluminum construction
- Rugged UCL basic winch easily adjusts ladder height
- Zinc-plated steel hardware for maximum corrosion resistance
- Ladder adjusts with 4ft (4') of travel
- Customizable to suit your specific application needs.



Portable Tanker Access Ladder System

The UCL Portable Tanker Access Ladder System (PTALS) is designed to provide safe access for work to elevated work areas. The system features lightweight aircraft aluminum construction, a rugged UCL basic winch and zinc-plated steel hardware for maximum corrosion resistance. The UCL Portable Tanker Access Ladder adjusts with 4ft (4') of travel. Customize the unit for your purposes by choosing system height, platform size, wheel kit and other fall-arrest / safety options.

Price:	Part #	Description
<input type="text"/>	17285	A) Base assembly Ladder Access System with URETHANE wheel kit (right), aluminum handrails and UCL Basic winch. *Please specify platform size and part number when ordering.
<input type="text"/>	17286	B) Base assembly Ladder Access System with PNEUMATIC wheel kit, aluminum handrails and UCL Basic winch. *Please specify platform size and part number when ordering.



The UCL Portable Tanker Access Ladder System meets the applicable requirements of the standards set out by the following:

- 1) ANSI A 14.3
Requirements for fixed ladders
- 2) OSHA 1910.26
Portable metal ladders
- 3) CSA Z11-M81
Portable ladders
- 4) OSHA 1910.23
Guarding floorwall openings & holes
- 5) Manitoba Workplace Safety & Health Division
Fall protection guidelines.

Refer to Vertical Chart for PTALS for additional ladder heights.

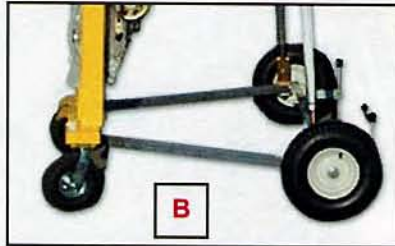

Platform Options

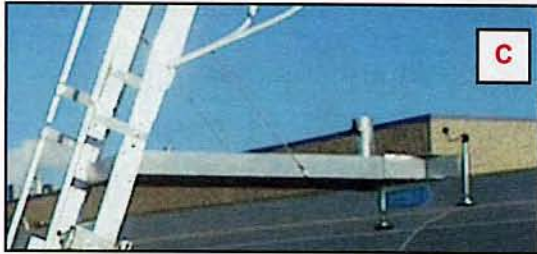

C) 54" Working Platform Assembly: This large platform can be customized by adding a corner sleeve mount and a pair of corner extension arms with adjustable screw legs for added stability (each sold separately, see 15086 & 15085 to purchase the combination that best suits your application).

Price:	Part #	Description
<input type="text"/>	15084	54" Working Platform Assembly

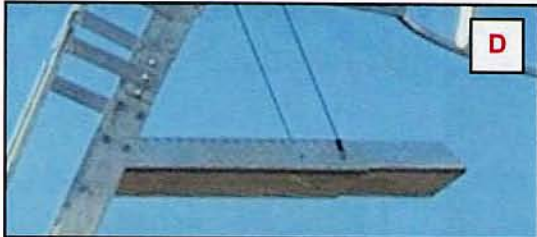

D) 28" to 42" Adjustable Step-up Extension: This adjustable platform is ideal for simple inspection and minor maintenance tasks. Recommended for use with the 5.5 ft. diameter guard rail cage.

Price:	Part #	Description
<input type="text"/>	15126	28" to 42" Adjustable Step-up Extension
<input type="text"/>	18419	48" Step-Up Extension Platform



E) Corner Sleeve Mount w/ adjustable extension arm: Customize your platform by adding a corner sleeve mount and a pair of corner extension arms with adjustable screw legs for added stability. For use with #15084 platform assembly (above).

Price:	Part #
<input type="text"/>	15086

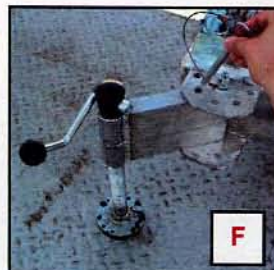

F) Corner Extension Arm: Increase platform stability with an adjustable extension arm. For use with Part # 15084 platform assembly (above).

Price:	Part #
<input type="text"/>	15085

Options



G) Fold up Mast: The UCL Fold-up Mast is ideal for general confined space entry/retrieval applications. The mast fits into the optional corner sleeve mount. To be used with a winch or SRL, sold separately.

Price: Part #: 11851

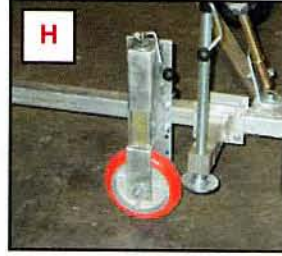

H) Side Moving Wheel Kit: Give your PTALS more mobility by adding the Side Moving Wheel kit. The kit comes with a pair of durable urethane wheels.

Price: Part #: 15349

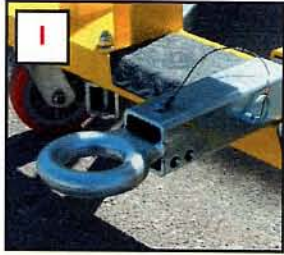

I) Trailer Hitch Attachment: Transport your unit easily around your facility behind a forklift or other low speed service vehicle. *Specify hitch type or ball size when ordering.*

Price:	Part #	Description
<input type="text"/>	16082	Trailer Hitch Attachment
Plus		
<input type="text"/>	13572	2" Ball Hitch Adapter
<input type="text"/>	13636	1 7/8" Ball Hitch Adapter
<input type="text"/>	16187	Pintle Hitch (shown - I)



J) Highway Transportation Package: For transporting the unit over long distances. Please call for pricing and availability.

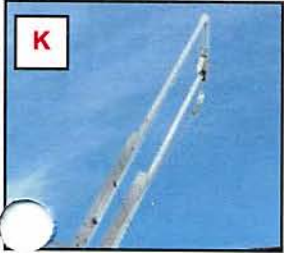

K) Fall Arrest Tie-off Post: This anchor point has a 1800 lbs. proof load which allows you to use SRLs, blocks and other shock absorbers with a M.A.F. rating of 900 lbs. Available only with Part # 15084.

Price: Part #: 15551



L) 5.5 ft diameter Guard Rail Cage: This option provides workers with added safety and comes with two outriggers equipped with non-slip rubber foot pads to provide increased unit stability. Also available with or without adjustable legs.

Price: Part #: 16044 (with adj. legs)
 17944 (w/o adj. legs)

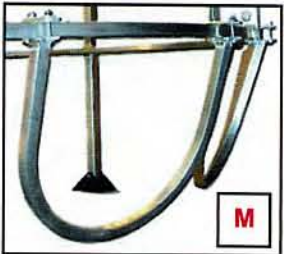

M) Fall Out Bar: Designed to fill the large gaps under the guard rails. The Fall Out Bar is positionable and mounts quickly and easily onto the guardrail cage. Adjusts specifically to your application needs. 4 Fall Out Bars are recommended per cage (sold separately). * Custom Fall Out Bars may be required for custom cages and/or applications

Price: Part #: 16269

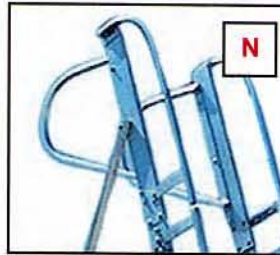

M) Upper Platform Handrails: Add a pair of Upper Platform Handrails for increased safety.

Price: Part #: 16138



O) Transfer Jacks for extra stability, add another 2 transfer jack assemblies to stabilize the UCL Portable Tanker Access Ladder System in place. Each 15" transfer jack has a capacity of 2000 lbs. Recommended to be ordered in pairs, unless you require a replacement (each sold separately).

Price: Part #: 17926 Description: Transfer Jacks

TOP VIEW

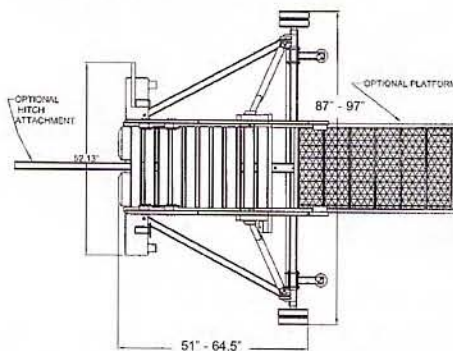

SIDE VIEW

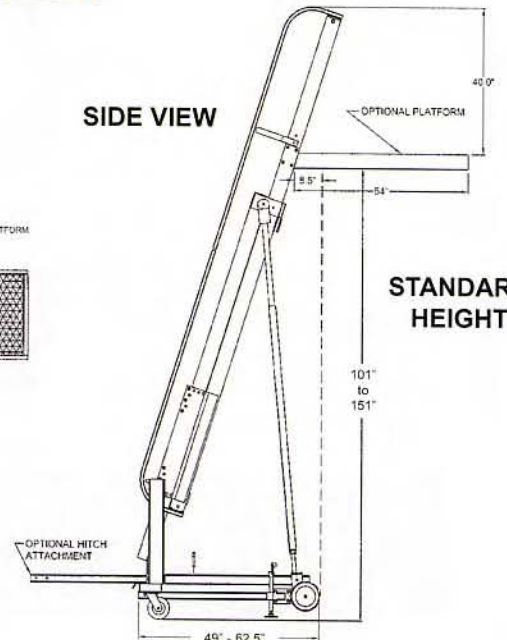

STANDARD HEIGHT

